

ACO Easyflow plastikiniai trapai







Informacija apie gaminį

Produkto privalumai

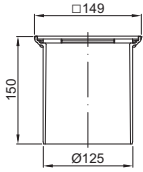
- Reguliuojamas sandarumo jungė
- Optimalios valymo galimybės
- Reguliuojamas trapo aukštis

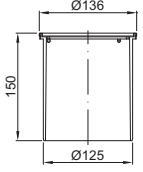

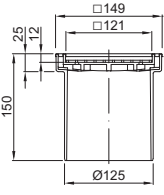

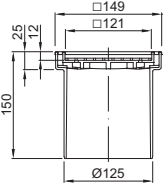

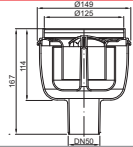

- Atitinka LST EN 1253-1
- Mažiausias aukštis: 89 mm
- Su integruota gumine tarpine tarp viršutinės ir apatinės dalių
- Viršutinė dalis pagaminta iš ABS
- Grotelės pagamintos iš nerūdijančiojo plieno
- Apkrovų klasė: K3

Viršutinės trapų dalys

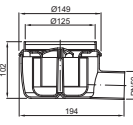

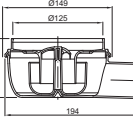

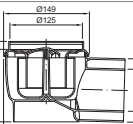

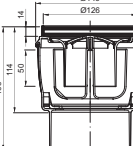

		Apibūdinimas	Aukščio reguliavimas [mm]	Gaminio kodas	Kaina, EUR/vnt.
		Trapo viršutinė dalis, ABS, skirta kvadratinėms grotelėms. Papildomai reikia pasirinkti apatinę dalį, kvadratinės grotelės ir pagal poreikį sandarinimo jungę.	18–135	5141.43.00	23,-
		Trapo viršutinė dalis, ABS, skirta apvalioms grotelėms. Papildomai reikia pasirinkti apatinę dalį, apvalias grotelės ir pagal poreikį sandarinimo jungę.	18–135	5141.46.00	25,-
		Trapo viršutinė dalis, ABS, skirta įklijuojamai plytelei. Papildomai reikia pasirinkti apatinę dalį ir pagal poreikį sandarinimo jungę.	26–135	5141.24.00	34,-
		Trapo viršutinė dalis, ABS skirta stikliniam dangčiui. Papildomai reikia pasirinkti apatinę dalį, dangtelį iš stiklo ir pagal poreikį sandarinimo jungę.	26–135	5141.38.00	27,-

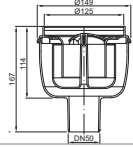
ACO Easyflow apatinės trapų dalys

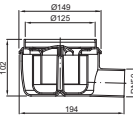
Trapo apatinė dalis be membranos sifone

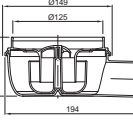

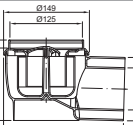

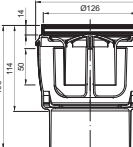





		Apibūdinimas	Pralaidumas, l/s (pagal EN 1253)	Gaminio kodas	Kaina, EUR/vnt.
		Trapo korpusas, PP, DN50, vertikalus, vandens aukštis sifone – 50 mm	1,5	2500.55.00	23,-
		Trapo korpusas, PP, DN50, horizontalus, vandens aukštis sifone – 50 mm	1,0	2500.05.00	23,-
		Trapo korpusas, PP, DN50, horizontalus, vandens aukštis sifone – 30 mm	0,8	2505.05.00	23,-
		Trapo korpusas, PP, DN100, horizontalus, vandens aukštis sifone – 50 mm	1,6	2700.05.00	23,-
		Trapo korpusas, PP, DN100, vertikalus, vandens aukštis sifone – 50 mm	1,6	2810.00.00	23,-

Trapo apatinė dalis su vandens garavimą sulaikančia membrana sifone

		Apibūdinimas	Pralaidumas, l/s (pagal EN 1253)	Gaminio kodas	Kaina, EUR/vnt.
		Trapo korpusas, PP, DN50, vertikalus, Vandens aukštis sifone – 50 mm	1,2	2500.55.15	27,-
		Trapo korpusas, PP, DN50, horizontalus, Vandens aukštis sifone – 50 mm	0,8	2500.05.15	27,-
		Trapo korpusas, PP, DN50, horizontalus, Vandens aukštis sifone – 30 mm	0,65	2505.05.15	27,-
		Trapo korpusas, PP, DN100, horizontalus, vandens aukštis sifone – 50 mm	1,3	2700.05.15	27,-
		Trapo korpusas, PP, DN100, vertikalus, vandens aukštis sifone – 50 mm	1,3	2810.00.15	27,-

ACO Easyflow grotelės

Trapo grotelės iš nerūdijančio plieno, 4 mm storio

	Dizainas	Gaminio kodas	Kaina, EUR/vnt.
 	Quadrato grotelės 140 x 140 mm, rakinamos	5141.21.22	87,-
	Quadrato grotelės 140 x 140 mm, nerakinamos	5141.08.22	53,-
	Quadrato apvalios grotelės	5141.25.22	53,-
 	Forest grotelės 140 x 140 mm, rakinamos	5141.21.26	87,-
	Forest grotelės 140 x 140 mm, nerakinamos	5141.20.26	53,-
	Forest apvalios grotelės	5141.25.26	53,-
 	Wave grotelės 140 x 140 mm, rakinamos	5141.21.28	87,-
	Wave grotelės 140 x 140 mm, nerakinamos	5141.08.28	53,-
	Wave apvalios grotelės	5141.25.28	53,-
 	Hawaii grotelės 140 x 140 mm, rakinamos	5141.21.29	87,-
	Hawaii grotelės 140 x 140 mm, nerakinamos	5141.20.29	53,-
	Hawaii apvalios grotelės	5141.25.29	53,-
 	Mix grotelės 140 x 140 mm, rakinamos	5141.21.30	87,-
	Mix grotelės 140 x 140 mm, nerakinamos	5141.20.30	53,-
	Mix apvalios grotelės	5141.25.30	53,-

Trapo dangtelis iš stiklo



	Dizainas	Gaminio kodas	Kaina, EUR/vnt.
	Stiklas, juodas	5141.38.01	115,-
	Stiklas, baltas	5141.38.02	115,-
	Stiklas, pilkas	5141.38.03	115,-

ACO Easyflow plastikiniai trapai

		Sifono patvanka (mm)	Reguliuojamas aukštis (mm)	Vandens pralaidumas (l/s)	Gaminio kodas	Kaina, EUR/vnt.
Ištekėjimo jungtis: DN 50						
		30 mm	7-75	0,8	2505.05.77	32,-
		30 mm	7-75	0,8	2505.00.77	32,-
Ištekėjimo jungtis: DN 70						
		50 mm	15-96	1,6	2710.55.77	38,-
Ištekėjimo jungtis: DN 100						
		50 mm	15-96	1,6	2810.55.77	38,-
		50 mm	15-96	1,6	2700.05.77	38,-
		50 mm	15-96	1,6	2700.00.77	38,-

ACO Easyflow plastikiniai trapai

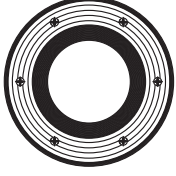
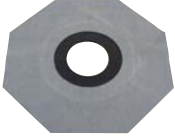
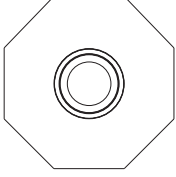
ACO Easyflow plastikinių trapų priedai

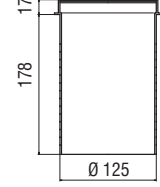
		Pavadinimas	Aprašymas	Gaminio kodas	Kaina, EUR/vnt.
		Hidroizoliacinis žiedas	<ul style="list-style-type: none"> ■ Pagrindinis žiedas pagamintas iš plastiko ■ Viršutinis prispaudžiamas žiedas pagamintas iš nerūdijančiojo plieno ■ Skirtas ruloninės hidroizoliacijos sandariam sujungimui su trapo korpusu 	2040.00.02	23,-
		Jungė tepamajai hidroizoliacijai	<ul style="list-style-type: none"> ■ Pagaminta iš plastiko su tampriu guminiu žiedu ir lanksčia geotekstile ■ Skirta tepamos hidroizoliacijos sandariam sujungimui su trapo korpusu 	2040.00.01	19,-
		Paaukštinimo elementas	<ul style="list-style-type: none"> ■ Plastikinis ■ Su įmontuota gumine tarpine ■ Tinkamas sandarinimo jungės pritvirtinimui 	2040.00.00	6,-

Trapų montavimas

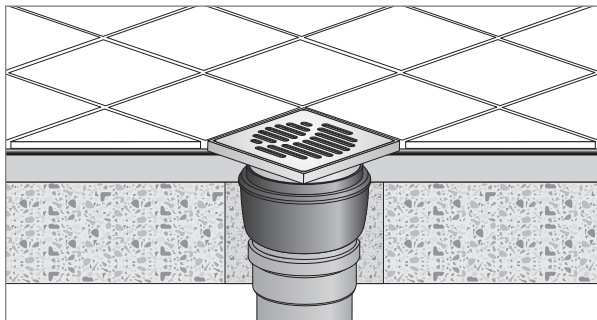

Trapas grindyse be hidroizoliacijos

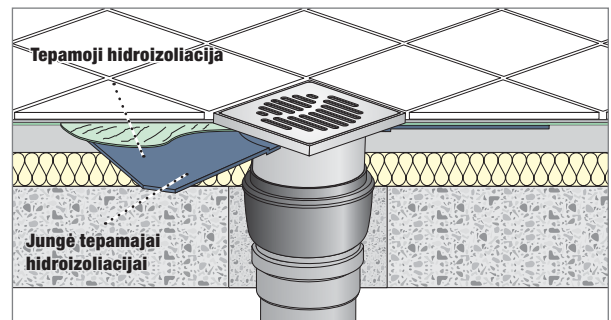

Trapas su jungė tepamajai hidroizoliacijai

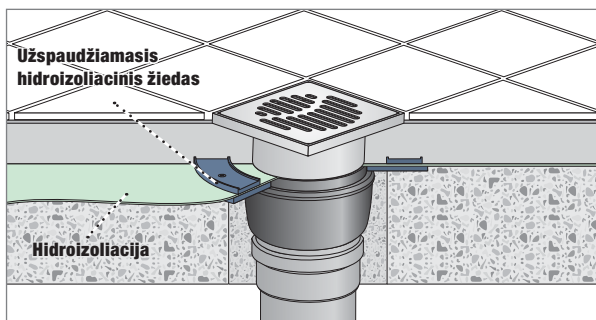

Trapas su vienu hidroizoliaciniu žiedu

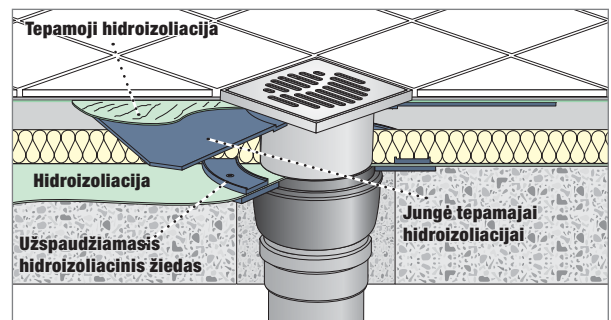

Trapas su jungė tepamajai hidroizoliacijai ir vienu hidroizoliaciniu žiedu